

MADbART

P.P.H. Madbart Rosikoń Bogusław
ul. Jeździecka 6, 05-077 Warszawa
tel. +48 501 083 866, +48 502 636 707
mail: madbart@onet.pl

KATALOG PRODUKTÓW

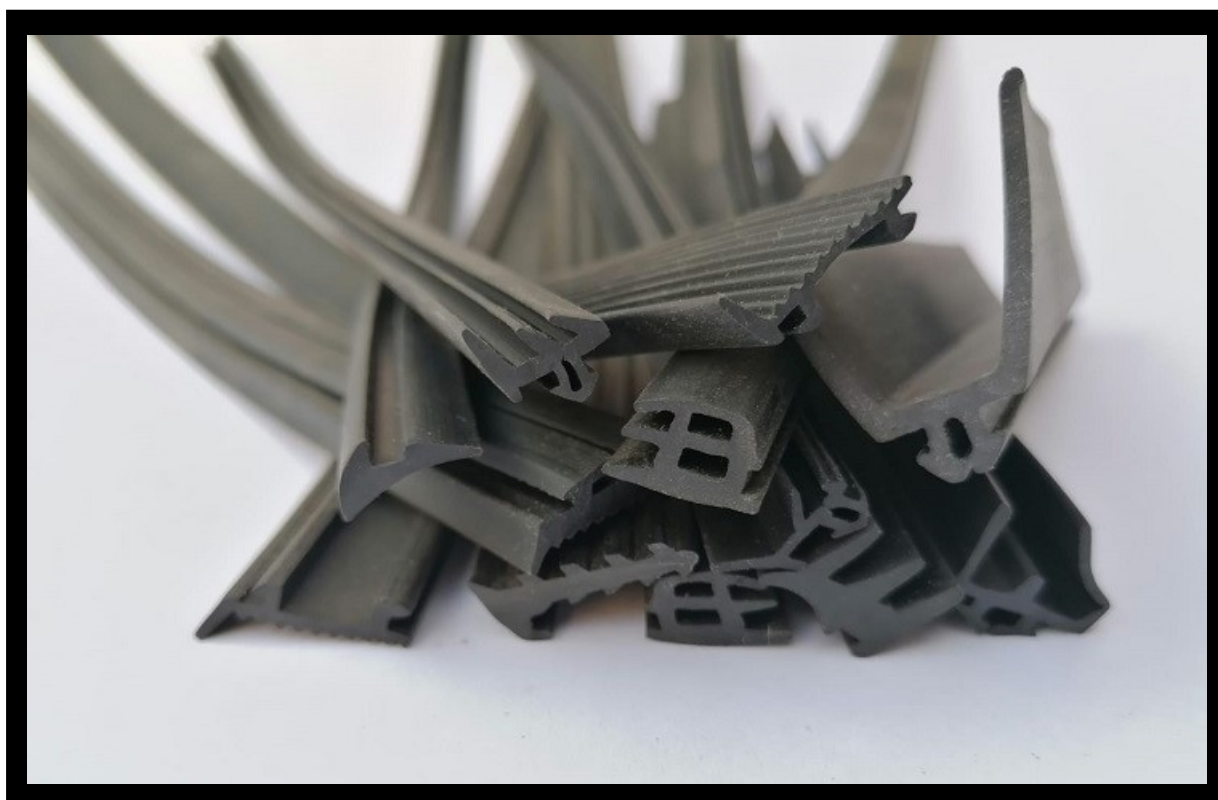

MADbART

P.P.H. Madbart Rosikoń Bogusław
ul. Jeździecka 6, 05-077 Warszawa
tel. +48 501 083 866, +48 502 636 707
mail: madbart@onet.pl

W naszej ofercie:







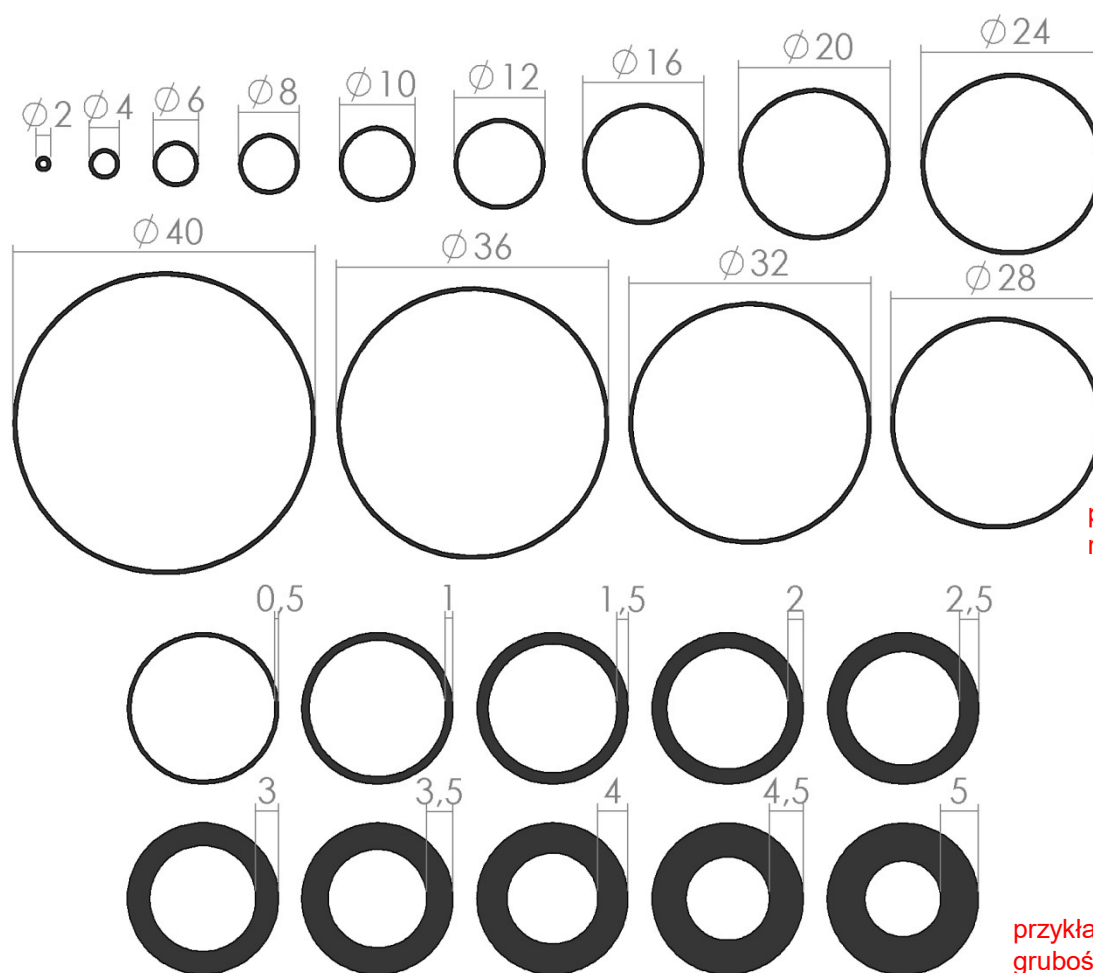



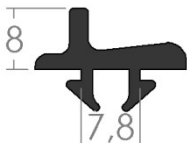

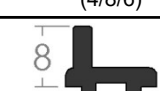
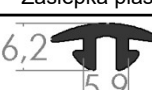
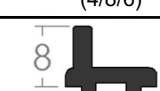
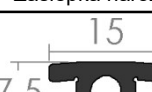

1. Węże i koszulki izolacyjne	Str.	2
2. Uszczelki do profili aluminiowych	Str.	3
3. Profile dowolne	Str.	16
4. Wykończenia naroży	Str.	19

Węże i koszulki izolacyjne





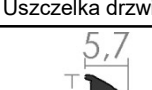
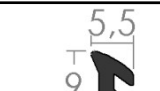
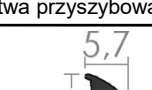
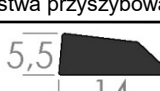





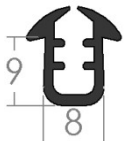

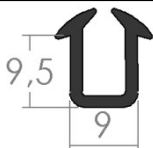
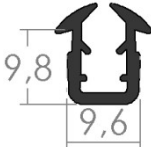

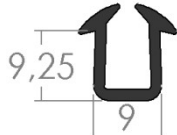
W asortymencie posiadamy węże i koszulki izolacyjne o średnicach od Φ 2 do Φ 40mm i grubościach ścianek od 0,5 do 5mm. W tym przedziale możemy dostosować się do konkretnych potrzeb klienta, zarówno w kwestii rozmiaru jak i koloru.



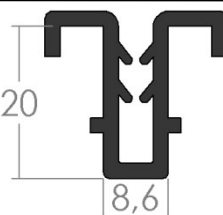
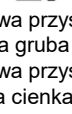
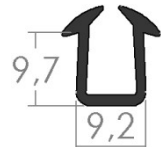
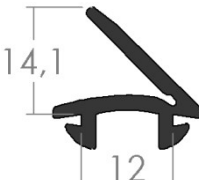
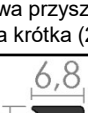
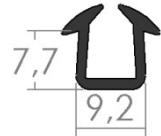
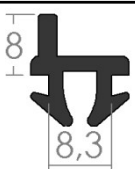

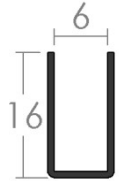

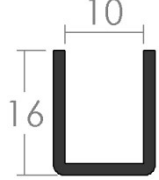





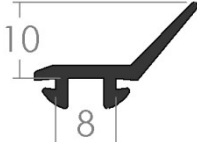
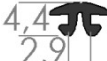



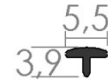



Uszczelki do profili aluminiowych

 <p>N1 – Uszczelka dwustronna szybowa (2,5/8/6)</p>	 <p>N12 – Listwa oporowa do drzwiczek uchylnych typ 6</p>	 <p>N21 – Podpora szybowa 10,5x6</p>
 <p>N2 (N51) – Zaślepka uniwersalna</p>	 <p>N13 – Uszczelka dwustronna szybowa (4/8/6)</p>	 <p>N22 – Zaślepka 3x5</p>
 <p>N3 – Zaślepka płaska (*/8/6)</p>	 <p>N14 – Listwa oporowa do drzwiczek uchylnych typ 5/8</p>	
 <p>N4 – Zaślepka narożna (*/6/5)</p>	 <p>N15 – Wspornik płyty</p>	
 <p>N5 – Element łączący typu H (*/8/6)</p>	 <p>N16 – Zaślepka maskująca przewody elektryczne</p>	
 <p>N6 – Listwa przyszybowa klinowa typu C (5/8/6)</p>	 <p>N17 – Listwa oporowa do drzwiczek uchylnych typ 5/6</p>	
 <p>N7 – Uszczelka drzwiowa (*/8/6)</p>	 <p>N18 – Uszczelka przylgowa</p>	
 <p>N8 – Listwa przyszybowa prosta (6/8/6)</p>	 <p>N19 – Listwa przyszybowa prosta (4/6/7)</p>	
 <p>N9 – Listwa przyszybowa prosta (6/8/6) wersja cieńsza</p>	 <p>N20 – Wkładka dystansowa</p>	
 <p>N11 – Listwa przyszybowa z wążem (5/8/6)</p>		

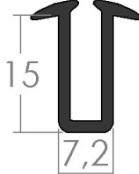
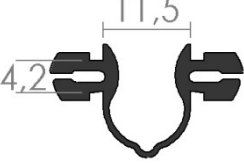





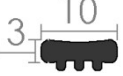
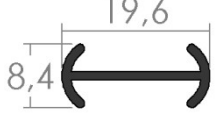
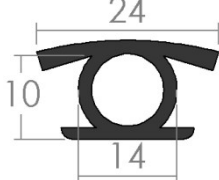



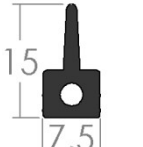

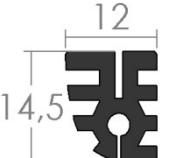
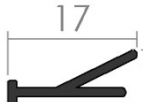

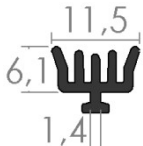

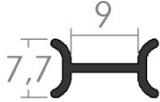

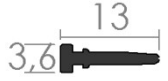
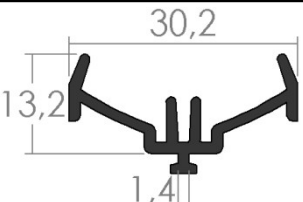
Uszczelki do profili aluminiowych

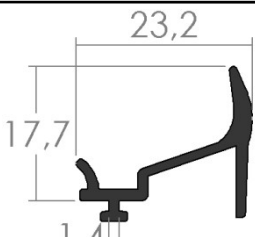
 <p>N52 – Uszczelka dwustronna szybowa (2,5/9/10)</p>	 <p>N58 – Listwa przyszybowa (6/9/10)</p>	 <p>N101 – Uszczelka wypełniająca szybowa (4/8/18)</p>
 <p>N53 – Uszczelka dwustronna szybowa (5/9/10)</p>	 <p>N59 – Uszczelka dwustronna szybowa (4/9/10)</p>	 <p>N102 – Listwa przyszybowa profilowana (2,4/*/*)</p>
 <p>N53-2 – Uszczelka dwustronna szybowa (6,2/9/10)</p>	 <p>N60 – Zaslepka maskująca 12</p>	 <p>N103-1 – Listwa przyszybowa klinowa – wersja gruba (2,4/5/10)</p>
 <p>N54 – Listwa przyszybowa klinowa (9/5/10)</p>	 <p>N61 – Uszczelka wygłuszająca</p>	 <p>N103-2 – Listwa przyszybowa klinowa – wersja cienka (2,4/5/10)</p>
 <p>N55 – Uszczelka dwustronna szybowa (6/9/10)</p>	 <p>N62 – Listwa maskująco-przylgowa 12</p>	 <p>N103-3 – Listwa przyszybowa klinowa – wersja krótka (2,4/5/10)</p>
 <p>N55 – 2 – Uszczelka dwustronna szybowa (??/??)</p>	 <p>N63 – Listwa oporowa do drzwiczek uchylnych typ 6/8,5</p>	 <p>N104 – Listwa przyszybowa</p>
 <p>N56 – Uszczelka dwustronna szybowa do ram przesuwnych (5/9/10)</p>		 <p>N105 – Uszczelka wypełniająca szybowa 6</p>
 <p>N57 – Uszczelka drzwiowa przymykowa</p>		 <p>N106 – Uszczelka wypełniająca szybowa 10</p>
		 <p>N107 – Uszczelka szybowa</p>

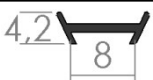
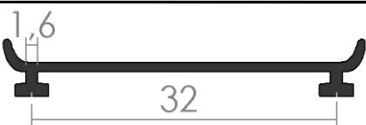
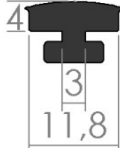
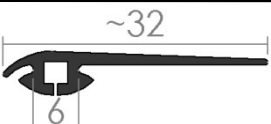
Uszczelki do profili aluminiowych

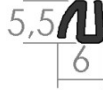
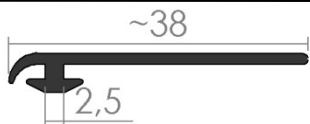
 <p>N108 – Uszczelka przymykowa</p>	 <p>N121 – Zaślepka mała</p>	 <p>N130 – Listwa okapnikowa</p>
 <p>N109 – Uszczelka przymykowa</p>	 <p>N122-1 – Listwa osłonowa (*4,5/6)</p>	 <p>N131 – Uszczelka dwustronna szybowa (4/8,5/9) N131-1 – Uszczelka dwustronna szybowa (5/10/10) N131-2 – Uszczelka dwustronna szybowa (6,2/10/10)</p>
 <p>N110 – Listwa mocująca</p>	 <p>N122-2 – Listwa osłonowa – skrócona (*4,5/6)</p>	 <p>N132 – Uszczelka przyszybowa klinowa (3,5/6,5/*)</p>
 <p>N111 – Listwa przyszybowa (6,3B/8/9)</p>	 <p>N123 – Profil wykańczający (*4,5/6)</p>	 <p>N133 – Zaślepka 6,6</p>
 <p>N112 – Listwa do poliwęglanu (6/12/8)</p>	 <p>N124 – Uszczelka dwustronna szybowa (2,2/6,5/12,5)</p>	 <p>N134 – Uszczelka przyszybowa klinowa (4/6,5/*)</p>
 <p>N113 – Uszczelka wypełniająca szybowa (4/*/15)</p>	 <p>N125 – Profil typu zawiasowego (*4,5/6)</p>	 <p>N135 – Nakładka schodowa</p>
	 <p>N126 – Profil wykańczający do naroży</p>	 <p>N136 – Uszczelka przyszybowa klinowa (2,5/6,5/*)</p>
	 <p>N127 – Zaślepka maskująca</p>	 <p>N137 – Uszczelka przyszybowa klinowa (3/6,5/*)</p>
	 <p>N128 – Zaślepka wypełniająca</p>	 <p>N138 – Element łączeniowy do drzwi przesuwnych</p>
	 <p>N129 – Zaślepka</p>	



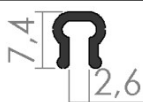









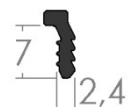

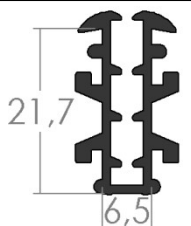

Uszczelki do profili aluminiowych

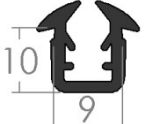
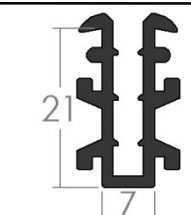
 <p>N139 – Nakładka uszczelniająca do drzwi łukowych</p>	 <p>N149 – Listwa uszczelniająca</p>	 <p>N157-1 – Uszczelka naszybowa (3/7/7)</p>
 <p>N140 – Wkładka łączeniowa</p>	 <p>N150 – Listwa uszczelniająca</p>	 <p>N157-2 – Uszczelka przyszybowa klinowa (3/7/*)</p>
 <p>N141 – Uszczelka przymykowa</p>	 <p>N151 – Uszczelka przylgowa</p>	 <p>N158-1 – Uszczelka naszybowa (4/7/7)</p>
 <p>N142 – Element łączeniowy do drzwi przesuwanych</p>	 <p>N152 – Uszczelka przylgowa</p>	 <p>N158-2 – Uszczelka przyszybowa klinowa (4/7/*)</p>
 <p>N143 – Listwa oporowa</p>	 <p>N153 – Uszczelka przylgowa</p>	 <p>N159 – Uszczelka szyby stałej (6/9/13,5)</p>
 <p>N144 – Zaślepka specjalna</p>	 <p>N154 – Uszczelka przylgowa</p>	 <p>N160 – Uszczelka boczna</p>
 <p>N145 – Uszczelka szybowa</p>	 <p>N155 – Listwa uszczelniająca</p>	 <p>N161 – Zaślepka</p>
 <p>N146-1 – Listwa oporowo maskująca</p>	 <p>N156 – Uszczelka naszybowa (2/7/7,5)</p>	 <p>N162 – Uszczelka przymykowa</p>
 <p>N146-2 – Listwa oporowo maskująca</p>	 <p>N163 – Uszczelka do cokołu</p>	 <p>N164 – Listwa z PVC do profilu LED</p>
 <p>N147 – Listwa uszczelniająca</p>	 <p>N165 – Uszczelka odbojowa</p>	
 <p>N148 – Listwa spinająca</p>		



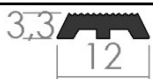
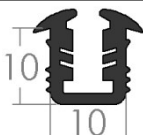
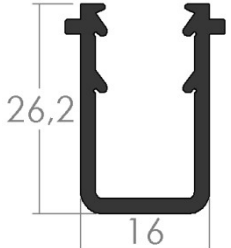
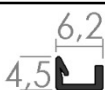
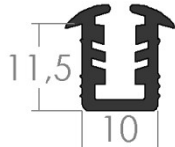

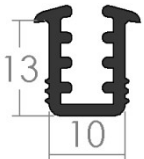
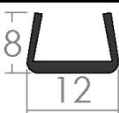

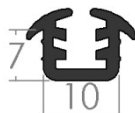
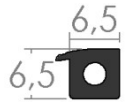
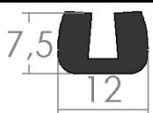
Uszczelki do profili aluminiowych

<p>N166 – Uszczelka szybowa (8,4/10/7,5)</p>	<p>N173-1 – Uszczelka przyszybowa klinowa (8/*/*)</p>	<p>N178 – Uszczelka wypełniająca typu H11,5 do szyby 5.5.4</p>
<p>N167 – Listwa z PVC do profilu LED</p>	<p>N173-2 – Uszczelka przyszybowa klinowa (10/*/*)</p>	<p>N179 – Uszczelka wypełniająca typu H17,5 do szyby 8.8.4</p>
<p>N168-1 – Uszczelka dystansowa 7 do szyby 6</p>	<p>N174 – Zaślepka maskująca</p>	<p>N180 – Uszczelka wypełniająca typu H13 do szyby 6.6.4</p>
<p>N168-2 – Uszczelka dystansowa 7,8 do szyby 5</p>	<p>N175 – Uszczelka łączeniowa typu H11,5 do szyby 5.5.4</p>	
<p>N168-3 – Uszczelka dystansowa 8,5 do szyby 4</p>	<p>N176 – Uszczelka dystansowa</p>	
<p>N169 – Uszczelka łączeniowa typu H13 do szyby 6.6.4</p>	<p>N177 – Zaślepka z PVC do oprawy LED</p>	
<p>N170 – Listwa przyszybowa klinowa (8/*/*)</p>		
<p>N171 – Listwa krawędziowo-kątowa (14/1/1,5)</p>		
<p>N172 – Uszczelka szybowa (24/*/*)</p>		

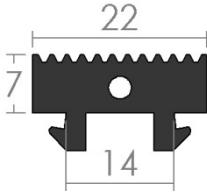
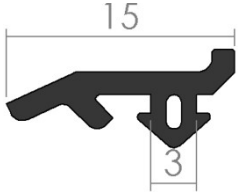
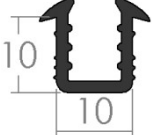
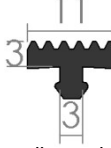
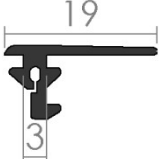
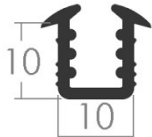
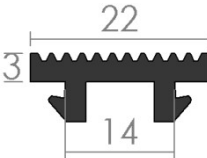
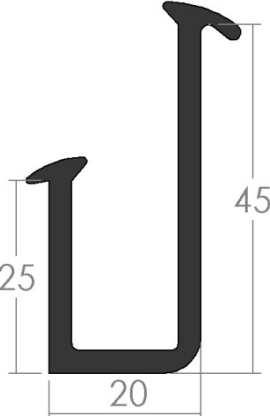
Uszczelki do profili aluminiowych

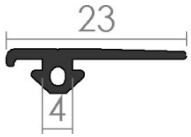
 <p>N201 – Uszczelka przyszybowa (4,5/*/*)</p>	 <p>N211-2 – Uszczelka podszybowa (4,5/12/*)</p>	 <p>N216 – Uszczelka dystansowa</p>
 <p>N202 – Uszczelka przyszybowa (4/*/*)</p>	 <p>N211-3 – Uszczelka podszybowa (6,2/12/*)</p>	 <p>N217 – Uszczelka podszybowa (4/10/8,5)</p>
 <p>N203 – Wypełniacz podszybowy (4/*/*)</p>	 <p>N212-1 – Uszczelka wypełniająca szybowa (2/*/*)</p>	 <p>N218 – Uszczelka podszybowa (4,5/10/8,5)</p>
 <p>N204 – Uszczelka dwustronna szybowa (4/9/10) N204-2 – Uszczelka dwustronna szybowa (4/10/10)</p>	 <p>N212-1 – Uszczelka wypełniająca szybowa (3/*/*)</p>	 <p>N219 – Uszczelka podszybowa (10/17/9,5)</p>
 <p>N205 – Uszczelka odbojowa</p>	 <p>N213 – Zaślepka</p>	 <p>N220 – Wypełniacz podszybowy (6/11,5/11)</p>
 <p>N206 – Nakładka schodowa</p>	 <p>N214-1 – Uszczelka dwustronna szybowa (4/10/10)</p>	 <p>N221 – Uszczelka wypełniająca szybowa (10/16/26,5)</p>
 <p>N207 – Wypełniacz podszybowy (4/*/*)</p>	 <p>N214-1 – Uszczelka dwustronna szybowa (4/10/11,5)</p>	 <p>N223 – Uszczelka szynowa (4/10/15)</p>
 <p>N208 – Uszczelka dwustronna szybowa (4/10/13)</p>	 <p>N215 – Uszczelka podszybowa (10/12/*)</p>	 <p>N224 – Uszczelka podszybowa (6,2/10/8,5)</p>
 <p>N209 – Listwa przyszybowa typu C</p>	 <p>N225 – Uszczelka dwustronna szybowa (4/10/7)</p>	
 <p>N210 – Listwa przyszybowa 6,5x6,5</p>		
 <p>N211-1 – Uszczelka podszybowa (4/12/*)</p>		

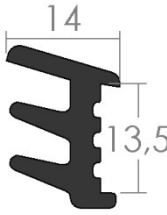
Uszczelki do profili aluminiowych

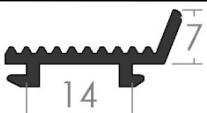
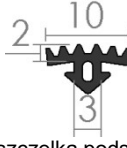
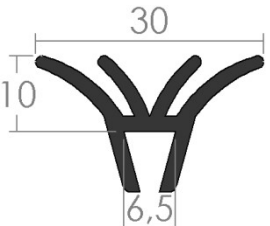
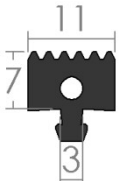
 <p>N226 – Uszczelka podszybowa (4/5/5)</p>	 <p>N233 – Uszczelka podszybowa 14/7 do balustrad (6i8/*/*)</p>	 <p>N239 – Uszczelka podszybowa 2,2/2 do balustrad (8,6i10/*/*)</p>
 <p>N227 – Uszczelka dwustronna szybowa (6,4/10/10)</p>	 <p>N234 – Uszczelka podszybowa 3/3 do balustrad (10i12/*/*)</p>	 <p>N240 – Listwa maskująca</p>
 <p>N228 – Uszczelka dwustronna szybowa (5,4/10/10)</p>	 <p>N235 – Uszczelka podszybowa 3/14 do balustrad (10i12/*/*)</p>	 <p>N241 – Uszczelka dwustronna szybowa (13,8/20/45-24)</p>
 <p>N229-1 – Wypełniacz podszybowy (4/18/8,5)</p>	 <p>N236 – Uszczelka przyszybowa montażowa (8/9,5/*)</p>	 <p>N242 – Listwa maskująca</p>
 <p>N229-2 – Wypełniacz podszybowy (4/18/8,5)</p>	 <p>N236 – Uszczelka przyszybowa montażowa wykończeniowa (13,5/6,5/*)</p>	 <p>N243 – Uszczelka dociskowa do NPV</p>
 <p>N230 – Uszczelka podszybowa</p>	 <p>N238 – Uszczelka podszybowa 3/2 do balustrad (8,6i10/*/*)</p>	
 <p>N231 – Listwa uszczelniająca</p>		
 <p>N232 – Uszczelka podszybowa 3/7 do balustrad (6i8/*/*)</p>		

Uszczelki do profili aluminiowych



N250 – Uszczelka podszybowa (4/10/7,5)



N251 – Uszczelka podszybowa (6/10/7,5)

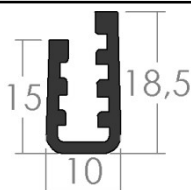

N252 – Uszczelka podszybowa (5,2/10/15-18,5)

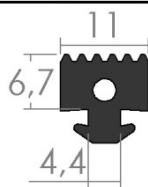

N301 – Uszczelka podszybowa 4,4/6,7 (10/*/*)

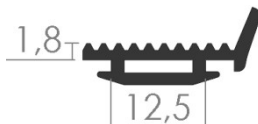

N302 – Uszczelka podszybowa 12,5/1,8 (10/*/*)



N303 – Uszczelka szybowa



N304 – Zaślepka 16

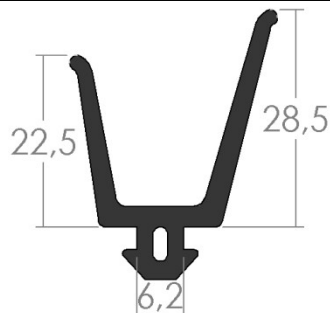

N305 – Uszczelka wargowa 6,2

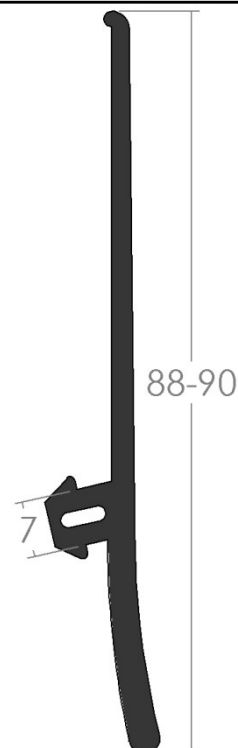



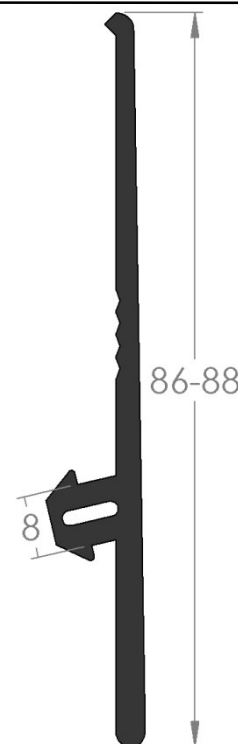







N306-1 – Uszczelka okapnikowa

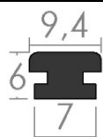

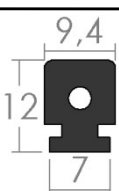
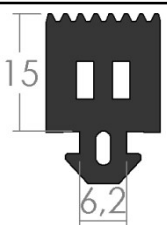

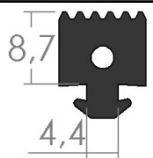
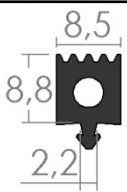
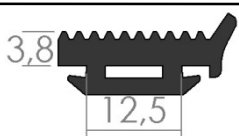
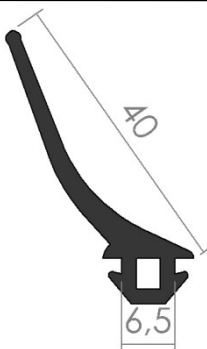





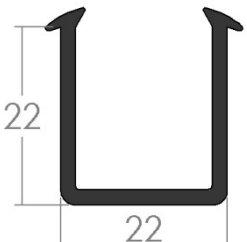
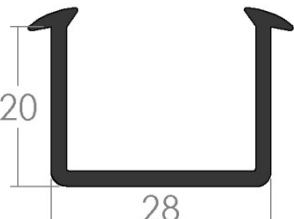

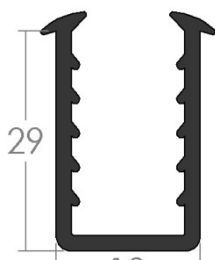
N306-2 – Uszczelka okapnikowa



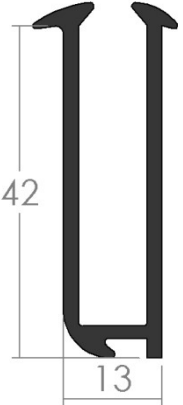
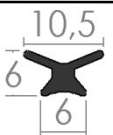

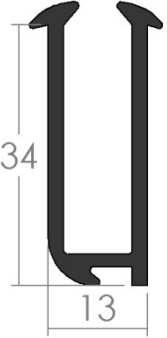
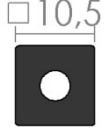
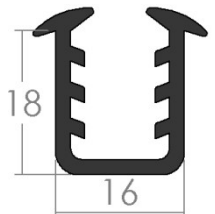

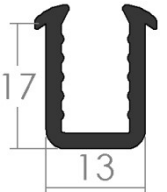
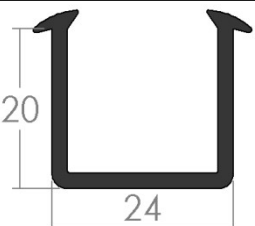
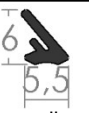
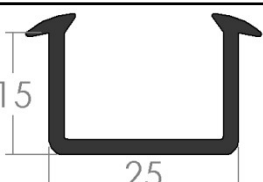



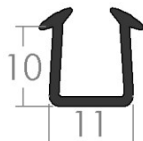
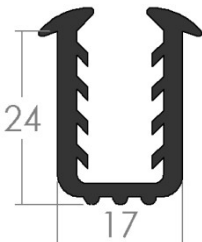

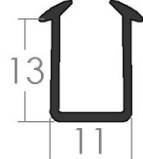
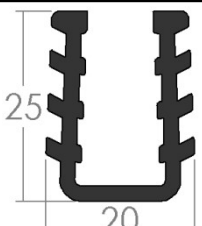

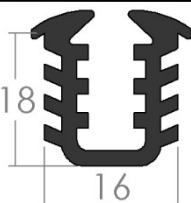

Uszczelki do profili aluminiowych

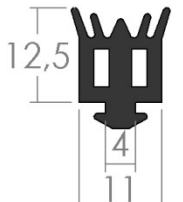
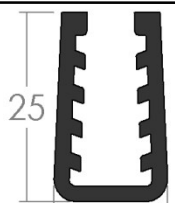
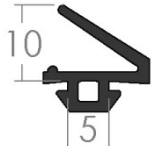
 <p>N307 – Uszczelka szybowa montażowa (10/*/*)</p>	 <p>N314 – Uszczelka do prowadnicy drzwi przesuwnych</p>	 <p>N320 – Uszczelka przyrymkowa do ościeżnicy</p>
 <p>N308 – Uszczelka szybowa montażowa (8/*/*)</p>	 <p>N315 – Ślizg-prowadnica ramy przesuwnej z PVC 6</p>	
 <p>N309 – Uszczelka szybowa montażowa (8/*/*)</p>	 <p>N316 – Ślizg-prowadnica ramy przesuwnej z PVC 12</p>	
 <p>N310 – Uszczelka podszybowa 6,2/15</p>	 <p>N317 – Uszczelka podszybowa 2,2/4 (16,5/*/*)</p>	
 <p>N311 – Uszczelka podszybowa 4,4/8,7 (8/*/*)</p>	 <p>N318 – Uszczelka podszybowa 2,2/8,8 (8,6/*/*)</p>	
 <p>N312 – Uszczelka podszybowa 12,5/3,8 (8/*/*)</p>	 <p>N319 – Listwa podokapnikowa 6,5/40</p>	
 <p>N313 – Uszczelka szybowa montażowa (8/*/*)</p>		

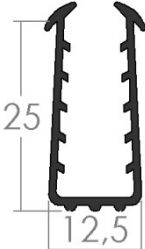
Uszczelki do profili aluminiowych

 <p>B1 – Uszczelka szybowa</p>	 <p>B10 – Uszczelka dwustronna szybowa (16,8/22/22)</p>	 <p>B16 – Uszczelka dwustronna szybowa (24/28/20)</p>
 <p>B2 – Uszczelka szybowa</p>	 <p>B11 – Uszczelka dwustronna szybowa (12,8/19/29)</p>	 <p>B17 – Uszczelka przymykowa do ścieżnicy drzwiowej</p>
 <p>B3 – Uszczelka drzwiowa</p>	 <p>B12 – Uszczelka przymykowa drzwi stalowych (VC60F)</p>	 <p>B18 – Uszczelka dwustronna szybowa (8,6/13/42)</p>
 <p>B4 – Uszczelka drzwiowa</p>	 <p>B13 – Uszczelka przymykowa drzwi stalowych ościeżnicy</p>	 <p>B19 – Uszczelka dwustronna szybowa (8,6/13/34)</p>
 <p>B5 – Podpora szybowa</p>	 <p>B14 – Uszczelka dwustronna szybowa (8,6/16/18)</p>	
 <p>B6 – Uszczelka szybowa</p>	 <p>B15 – Uszczelka dwustronna szybowa (8,6/13/17)</p>	
 <p>B7 – Uszczelka dwustronna szybowa (20/24/20)</p>		
 <p>B8 – Uszczelka drzwiowa</p>		
 <p>B9 – Uszczelka dwustronna szybowa (20/25/15)</p>		

Uszczelki do profili aluminiowych

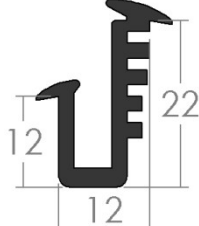
 <p>B20 – Uszczelka dwustronna szybowa (8,6/11/10)</p>	 <p>B26 – Uszczelka dwustronna szybowa (8,6/17/24)</p>	 <p>B33 – Uszczelka przyszybowa</p>
 <p>B21 – Uszczelka dwustronna szybowa (8,6/11/13)</p>	 <p>B27 – Uszczelka dwustronna szybowa (10,6/20/25)</p>	 <p>B34 – Uszczelka przyszybowa</p>
 <p>B22 – Uszczelka dwustronna szybowa (6/16/18)</p>	 <p>B28 – Uszczelka klinowa jednostronna (10,6/4,7/20)</p>	 <p>B35 – Uszczelka przyszybowa</p>
 <p>B23 – Uszczelka dwustronna szybowa (8,6/16/12)</p>	 <p>B29 – Uszczelka przymykowa</p>	 <p>B36 – Uszczelka szybowa</p>
 <p>B24 – Uszczelka dwustronna szybowa (8,6/15/25)</p>	 <p>B30 – Uszczelka przymykowa</p>	 <p>B37 – Uszczelka przyszybowa</p>
 <p>B25 – Uszczelka dwustronna szybowa (8,6/12,5/25)</p>	 <p>B31 – Uszczelka przyszybowa</p>	 <p>B38 – Wypełniacz podszybowy (5-6/**)</p>
	 <p>B32 – Uszczelka przyszybowa</p>	 <p>B39 – Uszczelka dociskowa</p>
		 <p>B40 – Uszczelka przylgowa</p>
		 <p>B41-1 – Uszczelka szybowa (4,6/12/22-12)</p>

Uszczelki do profili aluminiowych

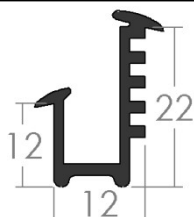

B41-2 – Uszczelka szybowa (6/12/22-12)

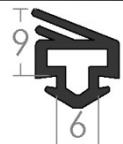

B42 – Uszczelka przylgowa



B43 – Uszczelka przyszybowa (6,2/*/*)



B44 – Uszczelka przylgowa do poliwęglanu



B45 – Uszczelka przylgowa do poliwęglanu



B46 – Uszczelka przylgowa do poliwęglanu

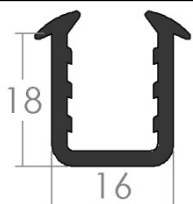

B47 – Uszczelka dwustronna szybowa (10,6/16/18)

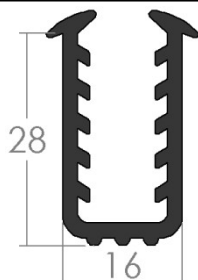

B48 – Uszczelka dwustronna szybowa (8,6/16/28)

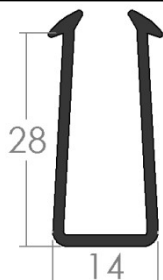

B49 – Uszczelka dwustronna szybowa (10,6/14/28)



B50 – Uszczelka przyszybowa



B51 – Uszczelka przyszybowa



B52 – Uszczelka przymykowa



B53 – Uszczelka przymykowa



B54 – Uszczelka oporowa

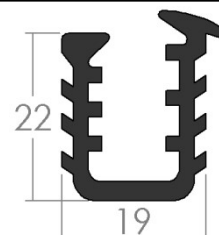

B55 – Uszczelka dwustronna szybowa (8,6/19/22)

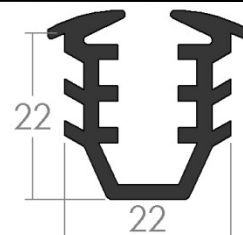

B56 – Uszczelka dwustronna szybowa (8,1/22/23)

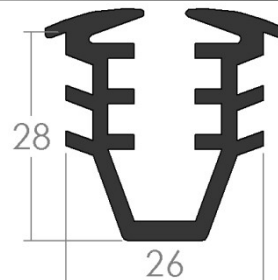

B57 – Uszczelka dwustronna szybowa (8,1/26/28)

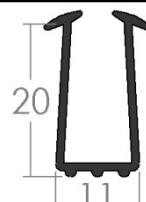

B58 – Uszczelka dwustronna szybowa (8,6/11/20)

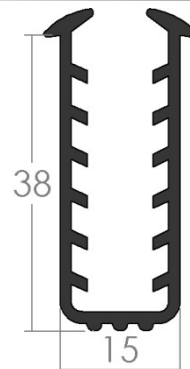

B59 – Uszczelka dwustronna szybowa (8,3/15/38)

Uszczelki do profili aluminiowych

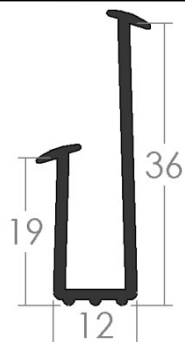

B60 – Uszczelka dwustronna szybowa
(8,6/12/19-36)

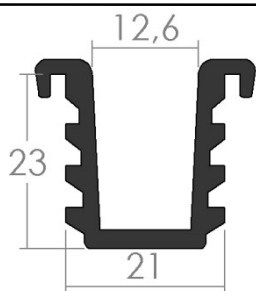

B61 – Uszczelka dwustronna szybowa
(12,6/21/23)



B80 – Uszczelka montażowa



B81 – Uszczelka montażowa



B82 – Uszczelka montażowa















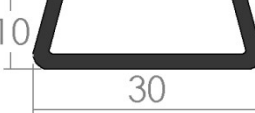





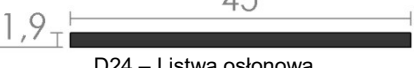

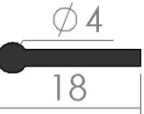



B83 – Uszczelka montażowa



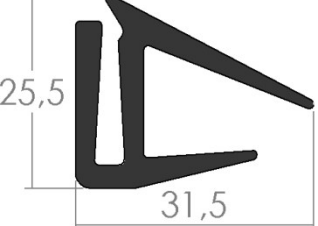
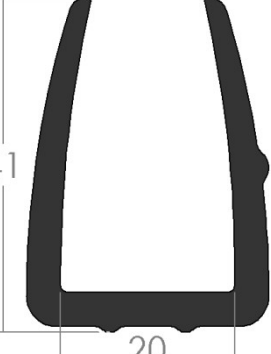



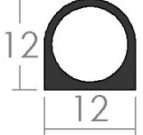





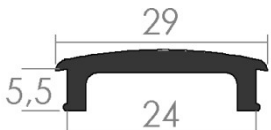

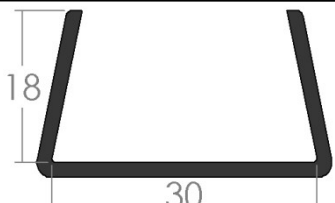
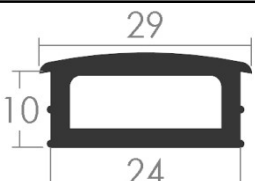
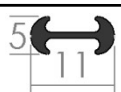

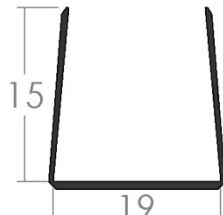
B84 – Uszczelka szybowa



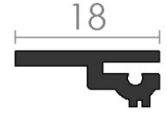
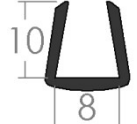
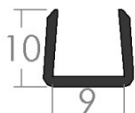

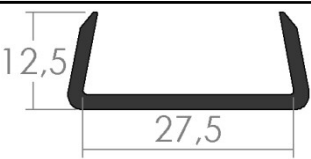





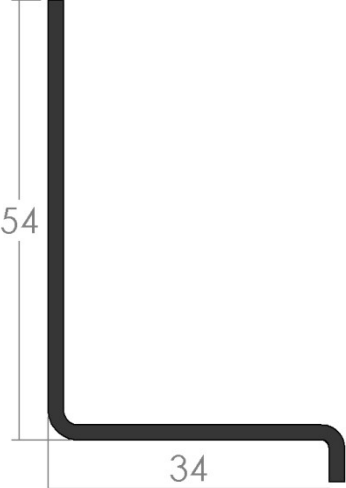

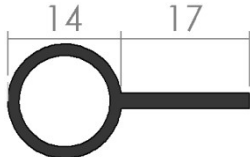

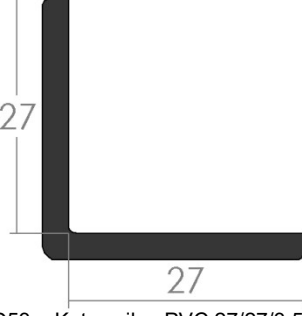

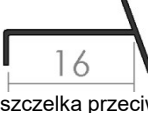
Profile dowolne

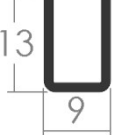
 <p>D1 – Sznur klinujący</p>	 <p>D12 – Profil osłonowo wykończeniowy</p>	 <p>D21 – Listwa wykończeniowa</p>
 <p>D2 – Profil osłonowo wykańczający 13</p>	 <p>D13 – Listwa osłonowa</p>	 <p>D22 – Uszczelka maskująca</p>
 <p>D3 – Profil osłonowo wykańczający 16</p>	 <p>D14 – Uszczelka maskująca</p>	 <p>D23 – Listwa maskująca</p>
 <p>D4 – Listwa ozdobna</p>	 <p>D15 – Uszczelka przylgowa</p>	 <p>D24 – Listwa osłonowa</p>
 <p>D5 – Listwa ozdobna</p>	 <p>D16 – Listwa zgarniająca</p>	 <p>D25 – Listwa maskująca</p>
 <p>D6 – Uszczelka przymykowa</p>	 <p>D17 – Nakładka maskująca</p>	 <p>D26 – Uszczelka kasetowa wąska</p>
 <p>D7 – Profil osłonowo wykończeniowy</p>	 <p>D18 – Listwa zgarniająca</p>	 <p>D27 – Uszczelka kasetowa szeroka</p>
 <p>D8 – Uszczelka maskująca</p>	 <p>D19 – Nakładka zabezpieczająca</p>	 <p>D29 – Uszczelka kasetowa szeroka</p>
 <p>D9 – Obrzeże meblowe 9</p>	 <p>D20 – Listwa osłonowa</p>	
 <p>D10 – Listwa osłonowa 42</p>		
 <p>D11 – Uszczelka drzwiowa</p>		

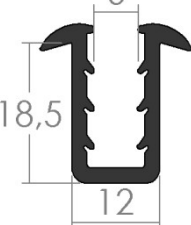

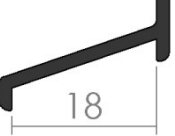









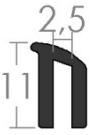

Profile dowolne

 <p>D30 – Uszczelka amortyzująca</p>	 <p>D40 – Listwa osłonowa typu U2</p>	 <p>D48 – Listwa wykończeniowa do blatu AL 25/29</p>
 <p>D31 – Profil osłonowo wykończeniowy typu H 4,5</p>	 <p>D41 – Listwa osłonowa typu U 30/18</p>	 <p>D48-2 – Listwa wykończeniowa do blatu AL 25/29</p>
 <p>D32 – Profil łączeniowy</p>		 <p>D33 – Listwa maskująca</p>
 <p>D34 – Listwa osłonowa 16</p>	 <p>D43 – Opaska krawędziowa typu U 19/15</p>	 <p>D49 – Uszczelka z PVC do balustrady stalowej 82/3,5</p>
 <p>D35 – Listwa osłonowa 16,5</p>	 <p>D44 – Listwa krawędziowa 33</p>	
 <p>D36 – Listwa osłonowa 14,5</p>	 <p>D45 – Listwa izolacyjna do zasilania LED</p>	
 <p>D37 – Profil typu U 8/10</p>	 <p>D46 – Opaska krawędziowa typu U 9/10</p>	
 <p>D38 – Listwa wykończeniowa typu h2</p>	 <p>D47 – Opaska krawędziowa typu U 27,5/12,5</p>	
 <p>D39 – Listwa wykończeniowa typu H 2</p>		
		 <p>D51 – Opaska krawędziowa typu U 13,5/10</p>

Profile dowolne

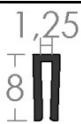
 <p>D52 – Płaskownik z PVC 84/3</p>	 <p>D56 – Kątownik z PVC 54/34/2</p>	 <p>S1 – Wypełniacz podszыbowy</p>
	 <p>D57 – Profil spawalnyczny „grzybek”</p>	 <p>S2 – Uszczelka specjalna drzewiowa</p>
	 <p>D58 – Profil spawalnyczny „grzybek 2”</p>	 <p>S3 – Wypełniacz podszыbowy (6,5/10/9,5)</p>
	 <p>D53 – Kątownik z PVC 27/27/3,5</p>	 <p>G1 – Uszczelka wargowa</p>
 <p>D54 – Uszczelka przeciwpыłowa</p>	 <p>G2 – Uszczelka wargowa</p>	 <p>S5 – Wypełniacz podszыbowy (6/9/13)</p>
 <p>D55 – Uszczelka typu H 1</p>	 <p>SD1 – Uszczelka wypełniająca (6/12/18,5)</p>	 <p>S6-1 – Wypełniacz podszыbowy (4/10/8,5)</p>
	 <p>SD2 – Listwa osłonowa 18</p>	 <p>S6-2 – Wypełniacz podszыbowy (4/10/9)</p>
		 <p>S6-3 – Wypełniacz podszыbowy (4,5/10/7)</p>
		 <p>S6-4 – Wypełniacz podszыbowy (5/10/7)</p>
		 <p>S7 – Wypełniacz podszыbowy (4/9/8,5)</p>

Wykończenia naroży

 <p>Wna1 – Profil typu U 1-1,5/7</p>	 <p>Wna11 – Profil typu U 1,2/3x8</p>	
 <p>Wna2 – Profil typu U 2/17</p>	 <p>Wna12 – Profil typu U 1,6/3xΦ6,5</p>	
 <p>Wna3 – Profil typu U 2,5/11</p>	 <p>Wna13 – Profil typu U 1,5/4</p>	
 <p>Wna4 – Profil typu U 3/14</p>	 <p>Wna14-1 – Profil typu C 12/5,8 Wna14-2 – Profil typu C 8/5,8 Wna14-3 – Profil typu C 12/7,3 Wna14-4 – Profil typu C 8/7,3 Wna14-5 – Profil typu C 10/5,8</p>	
 <p>Wna5 – Profil typu U 3/8</p>	 <p>Wna15 – Profil typu U 2/3,6</p>	
 <p>Wna7 – Profil typu U 1,25/8</p>		
 <p>Wna8 – Profil typu U 1,9/15</p>		
 <p>Wna9 – Listwa okapnikowa 0,7</p>		
 <p>Wna10 – Profil typu U 1/18</p>		